

Cell Type KR-1800SCE Specifications

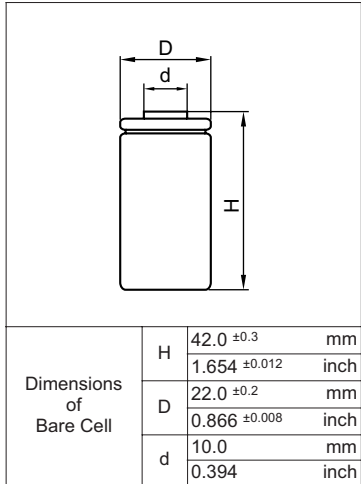

Nominal Capacity		1800mAh	
Nominal Voltage		1.2V	
Charging Current	Standard	180mA	
	Fast	2700mA	
Charging Time	Standard	14 to 16Hrs.	
	Fast	about 1Hr.	
Ambient Temperature	Charge	Standard	0°C to +45°C [+32°F to 113°F]
		Fast	0°C to +45°C [+32°F to 113°F]
	Discharge		-20°C to +60°C [-4°F to 140°F]
	Storage		-30°C to +50°C [-22°F to 122°F]
Internal Impedance (Av.) (at 50% discharge)		6.5mΩ (at 1000Hz)	
Weight		49g/1.73oz	
Dimensions(D)×(H) (with tube)		22.9 ⁰ ₋₁ × 43.0 ⁰ _{-1.2} mm	0.90 ⁰ _{-0.04} × 1.69 ⁰ _{-0.05} inch

Typical Characteristics

Charge

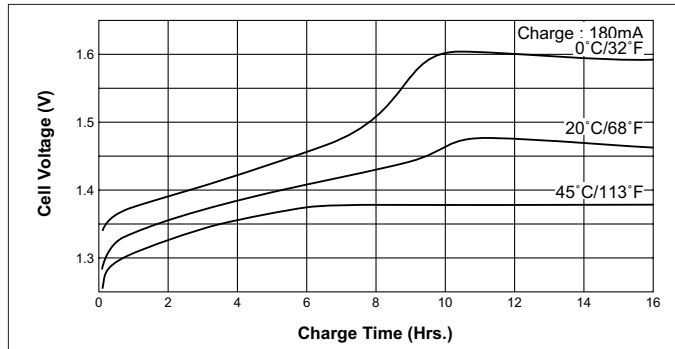

Discharge (at high rate)

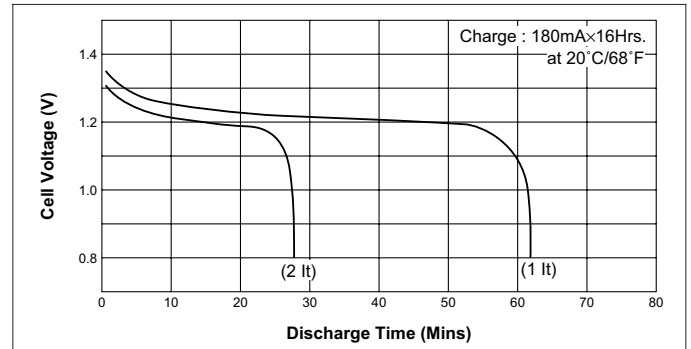

Charge

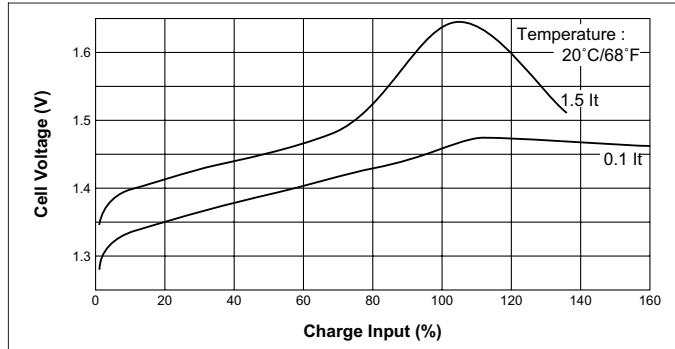

Discharge (at high rate)

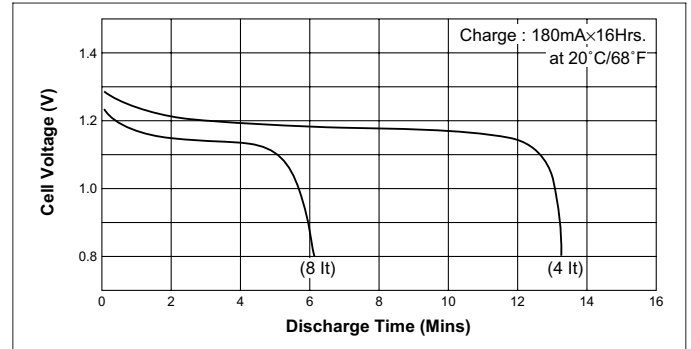

Discharge (at low rate)

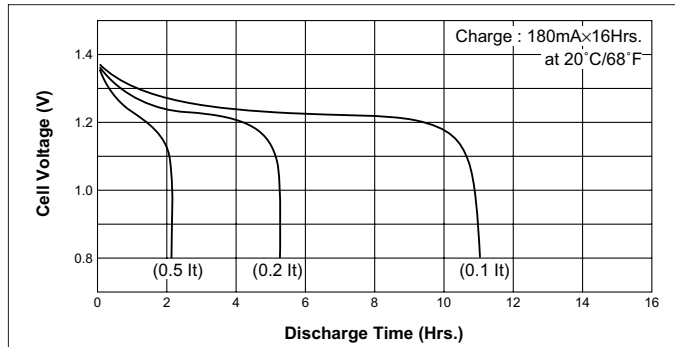

Temperature (Charge & Discharge)

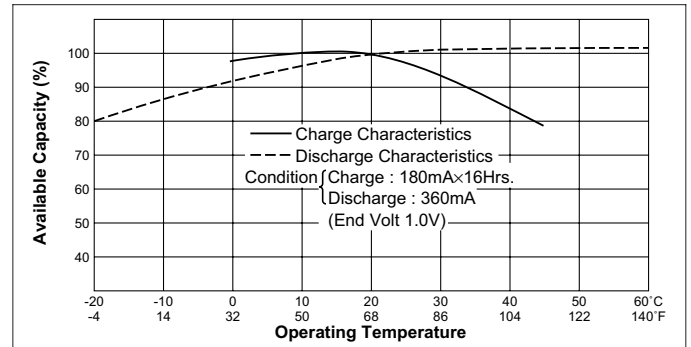

Mouser Electronics

Authorized Distributor

Click to View Pricing, Inventory, Delivery & Lifecycle Information:

[Panasonic:](#)

[KR-1800SCE](#)